*

(// // //)

:

. []

. []

[]

. []

:

-



[]

$$\frac{df}{dt} \quad f - \frac{df}{dt} \quad [] \quad []$$

[]

$$f - \frac{df}{dt}$$

[]

$$[] \quad \frac{df}{dt}$$

[]

$$[] \cdot \left(\frac{df}{dt}\right)$$

$$\frac{df}{dt}$$

$$\frac{df}{dt}$$

[]

$$\frac{df}{dt}$$



SPS

$$\frac{df}{dt} \quad [\quad]$$

DFT

[]

(

(SPS)

$$L = \frac{\text{Load} - \text{Generation}}{\text{Load}}$$

()

(SPS)

L ()

Generation

[]

L

SPS

[]

L

$$f = (\quad) (\quad) (\quad)$$

()

[]

$$LD = \frac{\frac{L}{1+L} - d(1 - \frac{f}{f_n})}{1 - d(1 - \frac{f}{f_n})} \quad ()$$

f p.u. L ()
d f_n

$$\frac{df}{dt}$$

[]

/ WSCC

[]

[]

/

$$f - \frac{df}{dt}$$

WSCC

[]

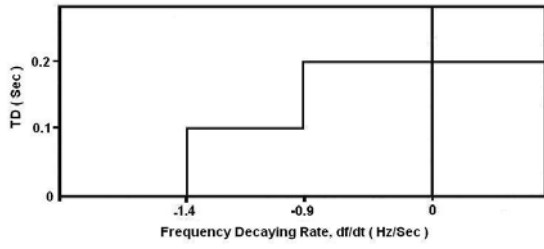

$$T_D - \frac{df}{dt}$$

()

$$\frac{df}{dt}$$

$$\frac{df}{dt}$$

$$LD - \frac{df}{dt}$$

$$LD - \frac{df}{dt}$$

LD

()

()

()

$$\frac{df}{dt}$$

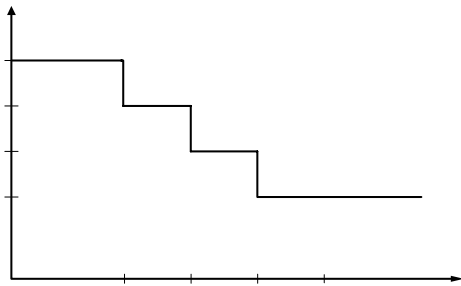

$$LD - \frac{df}{dt}$$

()

$$T_D - \frac{df}{dt}$$

$$T_D - \frac{df}{dt}$$

T_D

()

.....

$$\frac{df}{dt}$$

$$\frac{df}{dt}$$

$$\frac{df}{dt}$$

$$f - \frac{df}{dt}$$

()

[] []

$$f - \frac{df}{dt}$$

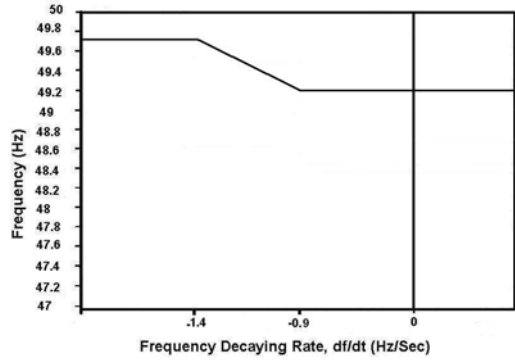

$$f - \frac{df}{dt}$$

$$\left| \frac{df}{dt} \right| \quad ()$$

$$\left| \frac{df}{dt} \right|$$

AVR

()

[]

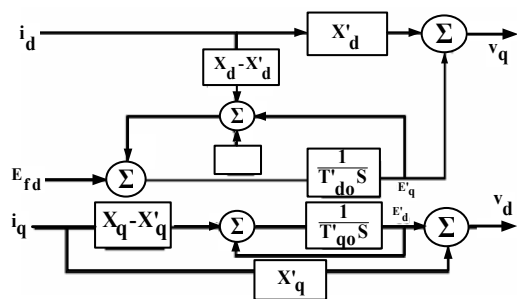

()

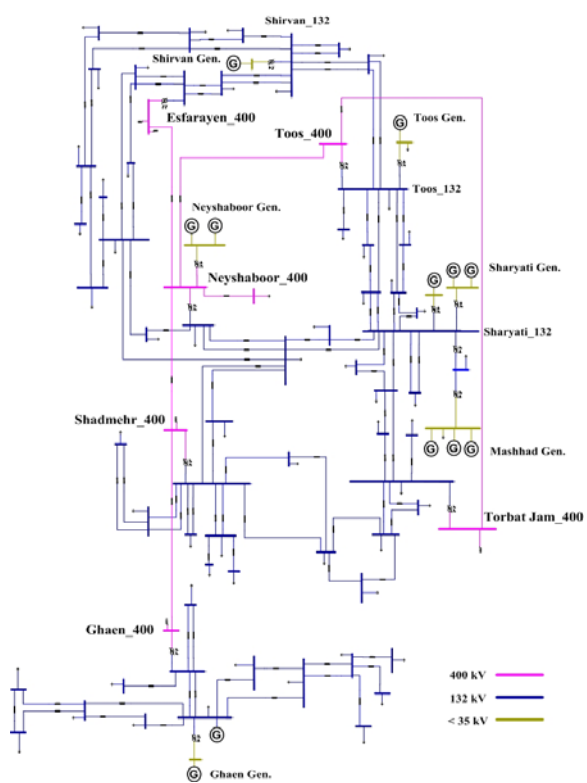

AGC

[]

()

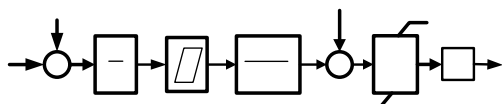

()

:T₁

:T₂

() :f₀ :R
 ΔF = f-f₀ :P_{Max}
 P₀ :Qa1 :P_{Min}
 :KPF1
 :KQF1 AVR
 :KQF2 AVR
 :KPV1
 :KPV2
 :KQV1
 :KQV2

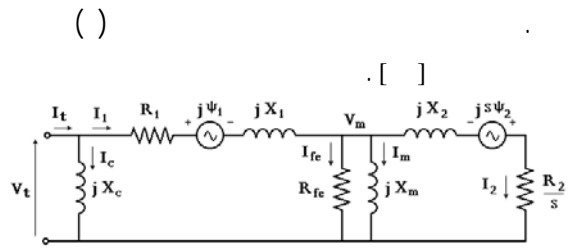
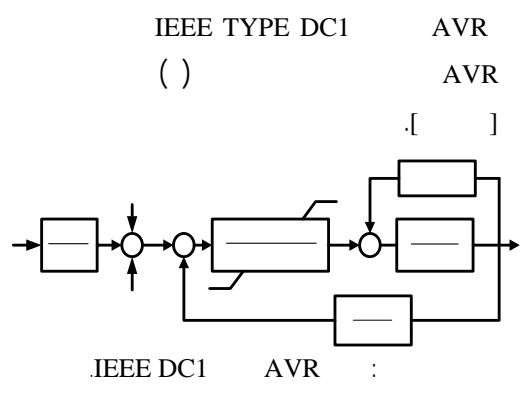

EPRI

$$\frac{P}{P_0} = P_{a1} \left(\frac{V}{V_0}\right)^{K_{PV1}} (1 + K_{PF1} * \Delta F) + P_{a2} \left(\frac{V}{V_0}\right)^{K_{PV2}} \quad ()$$

$$\frac{Q}{Q_0} = Q_{a1} \left(\frac{V}{V_0}\right)^{K_{QV1}} (1 + K_{QF1} * \Delta F) + Q_{a2} \left(\frac{V}{V_0}\right)^{K_{QV2}} (1 + K_{QF2} * \Delta F) \quad ()$$

$$P_{a1} + P_{a2} = 1 \quad ()$$

$$Q_{a1} + Q_{a2} = \frac{Q_0}{P_0} \quad ()$$

EPRI

:Q P

:Pa1

:Pa2

:Q₀ P₀

()

.(V₀) :V

.() :V₀

.() :f

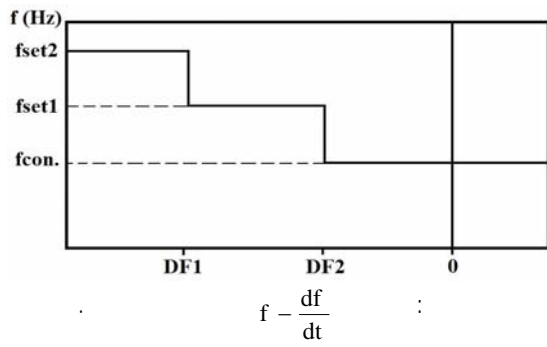

$$f - \frac{df}{dt}$$

()

AVR

$=$ MW
 $L = /$
 $d = /$
 $f () =$ Hz
 $() ()$
 LD MW / pu
 /
 ()

	(Hz)	LD
	/	%
		%
	/	%
	/	%

$$f - \frac{df}{dt}$$

$$f - \frac{df}{dt}$$

$$\left| \frac{df}{dt} \right| < |DF2|$$

()

$$|DF2| \leq \left| \frac{df}{dt} \right| \leq |DF1|$$

()

$$\left| \frac{df}{dt} \right| > |DF1|$$

()

f_{set1} f_{set2}

()

f_{set2}

DF2 DF1

Hz

/

Hz

/

DF2 DF1

DF1

$$f_{set1} = f_{con.} + 0.25$$

()

$$f_{set2} = f_{con.} + 0.5$$

$$|DF1| \left| \frac{df}{dt} \right|$$

f_{set1} ()

()

N

f_{set2}

()

DF1

$f_{con.}$

$$|DF1| = \text{Min}_{i=1}^N \left(\text{Max} \left| \frac{df}{dt} \right| \right) - 0.2 \quad ()$$

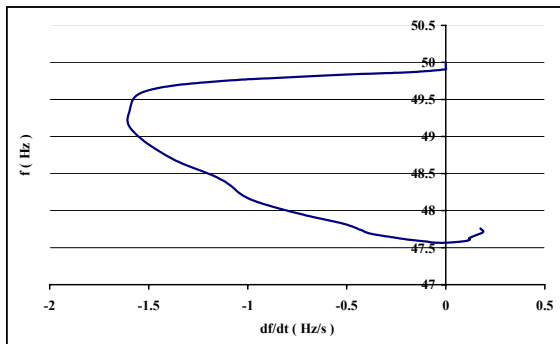

()

$$\left| \frac{df}{dt} \right| > |DF1|$$

$$f - \frac{df}{dt}$$

$$\text{Max} \left| \frac{df}{dt} \right|$$

/ Hz/s

$$f - \frac{df}{dt}$$

()

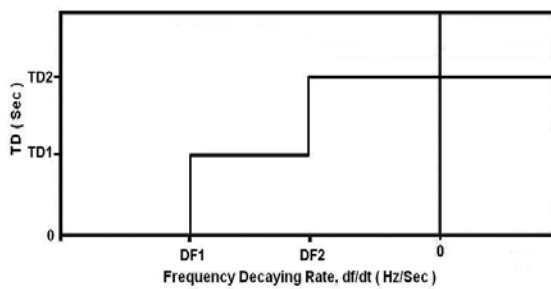

$$\text{Max} \left| \frac{df}{dt} \right|$$

$$|DF1| \quad ()$$

/ Hz/s

/

f_{set2}

DF1

DF2

N

()

N

$$T_D - \frac{df}{dt}$$

$$\frac{df}{dt} \quad LD - \frac{df}{dt}$$

$$\frac{df}{dt} \quad LD \quad ()$$

$$T_D - \frac{df}{dt}$$

$$T_D - \frac{df}{dt} \quad ()$$

DF2 DF1

$$f - \frac{df}{dt}$$

$$f - \frac{df}{dt}$$

$$LD - \frac{df}{dt}$$

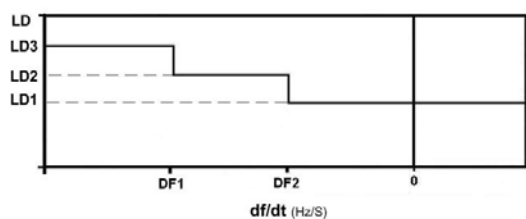

$$LD - \frac{df}{dt}$$

$$f - \frac{df}{dt} \quad ()$$

DF2 DF1

$$\left| \frac{df}{dt} \right| < |DF2|$$

$$|DF2| \leq \left| \frac{df}{dt} \right| \leq |DF1|$$

$$\left| \frac{df}{dt} \right| > |DF1|$$

LD2 LD1

LD3

$$/ \quad () \quad () \quad L$$

$$()$$

/ s

TD2

TD1

/ s TD2

$$() \quad ()$$

LD

/ s

TD2 TD1

/ s

()

()

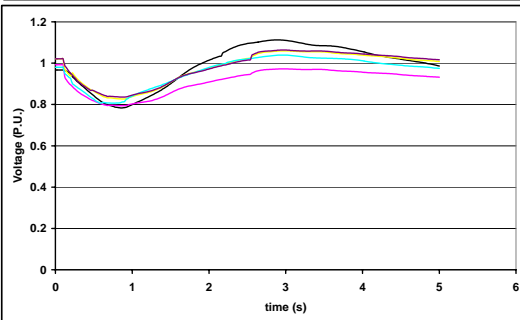
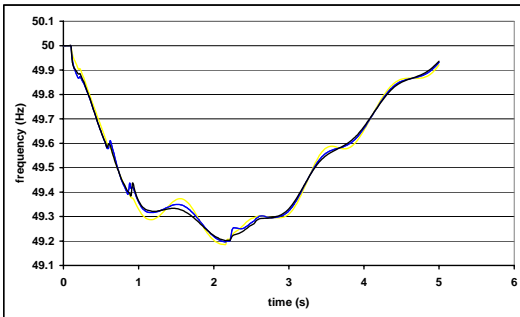
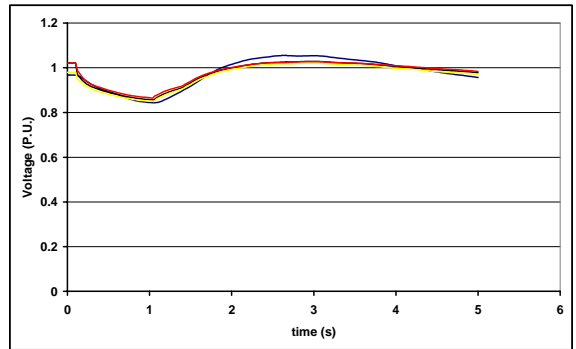
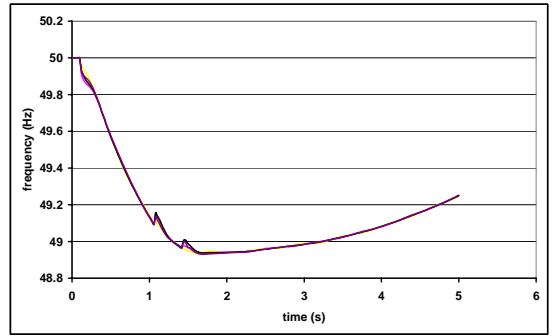
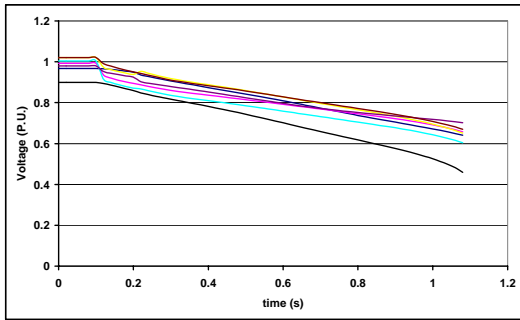
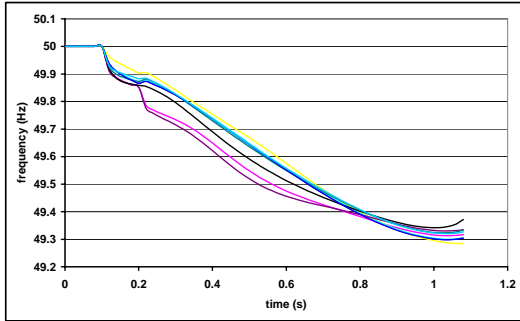

$$\dot{f} = \frac{df}{dt}$$

$$T_D = \frac{df}{dt}$$
$$LD = \frac{df}{dt}$$

$$T_D = \frac{df}{dt}$$
$$LD = \frac{df}{dt}$$

$$f = \frac{df}{dt}$$

$$f = \frac{df}{dt}$$

$$f = \frac{df}{dt}$$

()

/ Hz/s

$$\frac{df}{dt}$$

$$f = \frac{df}{dt}$$

()

()

$$T_D = \frac{df}{dt}$$
$$LD = \frac{df}{dt}$$

$$f = \frac{df}{dt}$$

$$f = \frac{df}{dt}$$

$$f - \frac{df}{dt}$$

)

(

:

/

$$f - \frac{df}{dt}$$

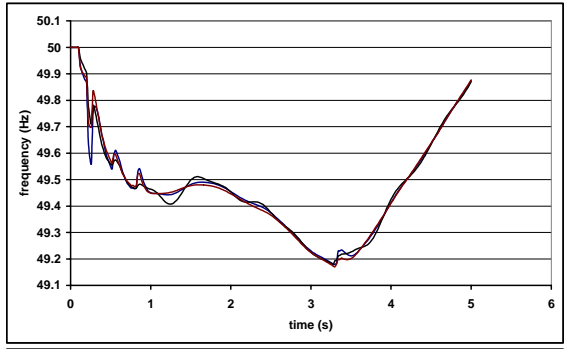

$$f - \frac{df}{dt}$$

:

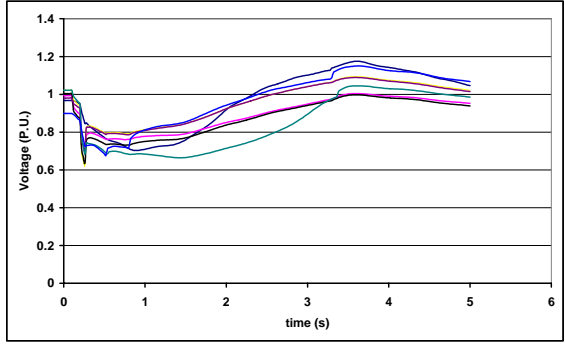

$$f - \frac{df}{dt}$$

:

$$f - \frac{df}{dt}$$

()

:

/

$$f - \frac{df}{dt}$$

$$f - \frac{df}{dt}$$

:

$$f - \frac{df}{dt}$$

$$T_D - \frac{df}{dt}$$

$$LD - \frac{df}{dt}$$

()

$$LD - \frac{df}{dt} \quad T_D - \frac{df}{dt}$$

$$f - \frac{df}{dt}$$

$$f - \frac{df}{dt}$$

	+	$f - \frac{df}{dt}$
	+	$f - \frac{df}{dt}$
	+ +	$f - \frac{df}{dt}$
	+ +	$f - \frac{df}{dt}$
	+ +	$f - \frac{df}{dt}$
	+	$f - \frac{df}{dt}$
	+ +	$f - \frac{df}{dt}$
		$f - \frac{df}{dt}$
	+	$f - \frac{df}{dt}$

()

$$T_D - \frac{df}{dt}$$

$$LD - \frac{df}{dt}$$

$$f - \frac{df}{dt}$$

-
- 1 - Horowitz, S. H. and Phadke, A. G. (2003). "Boosting immunity to blackouts." *IEEE Power and Energy Magazine*.
 - 2 - Jonson, M. (2003). *Protection strategies to mitigate major power system breakdowns*, Ph .D. Dissertation, Chalmers University of Technology, Goteborg, Sweden.
 - 3 - Etezadi-Amoli, M. (1999). "On underfrequency load shedding schemes." *Proceedings of the 22'nd Annual North American Power Symposium*, PP. 172-180.
 - 4 - Delfino, B., Massucco, S., Morini, A., Scalera, P. and Silvestro, F. (2001). "Implementation and comparison of different underfrequency load shedding schemes." *IEEE Power Engineering Society Summer Meeting*, Vol. 1, PP. 307-312.
 - 5 - Concordia, C., Fink, L. H. and Poullikkas, G. (1995). "Load shedding on an isolated system." *IEEE Trans. on Power Systems*, Vol. 10, No. 3, PP. 1467 – 1472.
 - 6 - Nagpal, M., Moshref, A., Shukri, Z., Vijayan, J. T., Chan, D. and Henville, C. (1997). "Dynamic simulations optimize application of an underfrequency load shedding scheme." *24'th Annual Western Protective Relaying Conference*.
 - 7 - Taylor, C. W. (1992). "Concepts of undervoltage load shedding for voltage stability." *IEEE Trans. on Power Delivery*, Vol. 7, No. 2, PP. 480 – 488.
 - 8 - Shih, L. J. , Lee, W. J., Gu, J. C. and Moon, Y. H. (1991). "Application of df/dt in power system protection and its implementation in microcontroller based intelligent load shedding relay." *Industrial and Commercial Power Systems Technical Conf.*, PP. 11-17.
 - 9 - Anderson, P. M. and Mirheydar, M. (1992). "An adaptive method for setting underfrequency load shedding relays." *IEEE Trans. on Power Systems*, Vol. 7, No. 2, PP. 647 – 655.
 - 10 - Aik, D. L. H. (2006). "A general-order system frequency response model incorporating load shedding: analytic modeling and application." *IEEE Trans. on Power Systems*, Vol. 21, No. 2, PP. 709 – 717.
 - 11 - Lindahl, S., Runvik, G. and Stranne, G. (1997). "Operational experience of load shedding and new requirements on frequency relays." *International Conf. on Developments in Power System Protection*, PP. 262-265.
 - 12 - Seyedi, H., Sanaye Pasand, M. and Dadashzadeh, M. R. (2006). "Design and simulation of an adaptive load shedding algorithm using a real network ." *IEEE Power India Conference*, April 10-12.
 - 13 - Abusharkh, M. F. and Hiyasat, A. A. (1989). "Load shedding scheme of the Jordanian national power system." *4'Th International Conf. on Developments in Power System Protection*, PP. 96-101.
 - 14 - Seyedi, H., Sanaye Pasand M. and Dadashzadeh, M. R. (2006). "Application of an adaptive under frequency load shedding scheme." *International Conf. on Power System Protection*, Sept. 6-8.
 - 15 - Liu, C. C., Jung, J., Heydt, G. T., Vittal, V. and Phadke, A. G. (2000). "Conceptual design of the strategic power infrastructure defense (SPID) system." *IEEE Control System Magazine*, Vol. 49, PP. 40-52.
 - 16 – Jung, J. and Liu, C. C. (2001). "Multi-agent technology for vulnerability assessment and control." *IEEE PES Summer Meeting*.
 - 17 - Jung, J., Liu, C. C., Tanimoto, S. L. and Vittal, V. (2002). "Adaptation in load shedding under vulnerable operating conditions." *IEEE Trans. on Power Systems*, Vol. 17, No. 4, PP. 1199 – 1205.
 - 18 - Tomsic, T., Verbic, G. and Gubina, F. (2005). "Revision of the underfrequency load shedding scheme of the Slovenian power system." *IEEE PES General Meeting*.
 - 19 - Anderson, P. M., Le Reverend, B. K. (1996). "Industry experience with special protection schemes." *IEEE Trans. on Power Systems*, Vol. 11, No. 3, PP. 1166 – 1179.
 - 20 - Jones, J. R. and Kirkland, W. D. (1988). "Computer algorithm for selection of frequency relays for load shedding." *Computer Applications in Power*, Vol. 1, PP. 21-25.
 - 21 - *WECC coordinated off-nominal frequency load shedding and restoration plan*, (1997). Final report.
-

-
- 22 - Dadashzadeh, M. R. (2004). *Dynamic simulation and evaluation of load shedding algorithms in power systems*, M. Sc. Dissertation, University of Tehran.
- 23 - Available at www.tavanir.org.ir
- 24 - *IEEE working group on methods of system preservation during underfrequency conditions*, Power System Relaying Committee, 'A status report on methods used for system preservation during underfrequency conditions', (1975). IEEE Trans. on Power Apparatus and Systems, vol. PAS-94, No. 2.
- 25 - *PSAF software user's guide and reference manual*, (1999). CYMSTAB for windows, CYME international Inc.
- 26 - Anderson, P. M. and Fouad, A. A. (2003). "Power system control and stability." *IEEE Press*.
- 27 - Kundur, P. S. (1993). *Power system stability and control*, Mc Grow-Hill, Inc.

- 1 - System Protection Schemes
- 2 - Event Based
- 3 - Response Based
- 4 - Zero Crossing
- 5 - Least Square Error
- 6 - Orthogonal Filters
- 7 - Discrete Fourier Transform
- 8 - Adaptive
- 9 - Lumped Model
- 10 - Automatic Generation Control
-